

# TP04 Terminal Panels Series

## Instruction Sheet

- Warning**
- ✓ Please read this instruction carefully before use.
  - ✓ Switch off the power before wiring.
  - ✓ The display panel of TP04 series is waterproof. But please prevent grease, corrosive liquids and sharp objects from contacting the TP04 series.
  - ✓ The TP04 series require 24VDC input power. DO NOT connect input AC power supply to any of the RS-485 communication port; otherwise serious damage may occur. Check all the wiring again before switching on the power.
  - ✓ DO NOT touch any terminal when the power is switched on. DO NOT touch any internal circuit in 1 minute after the power is switched off.
  - ✓ Make sure the ground terminal is correctly grounded in order to prevent electromagnetic interference.
  - ✓ Please use the fixed support accessory which is packed together with the product provided by Delta. DO NOT tighten the screws out of the normal torque specifications; otherwise serious damage may occur.

## 1 Introduction

### 1.1 Model Explanation

Thank you for choosing Delta TP Series. TP04G-AS2 has the features of high resolution 128x64 dots and is able to display 8x4 Chinese character. It provides multilingual display and two built-in communication ports, one is for RS-232 / RS-422 and the other is for RS-485. RS-232 and RS-485 can be used simultaneously. Besides, it also supports built-in RTC, communication / alarm LED indicators. The user can purchase program copy card (optional) to copy settings and programs quickly and save download time. Regarding the editing software, there are various objects and images for the user's requirements.

#### ❖ Nameplate Explanation

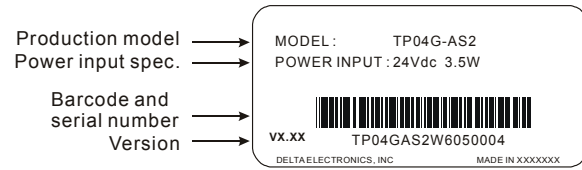

NOTE: The words of "MADE IN XXXXX" will be different due to the manufacturing location. Please refer to the actual product for exact description.

#### ❖ Model / Serial No. Explanation

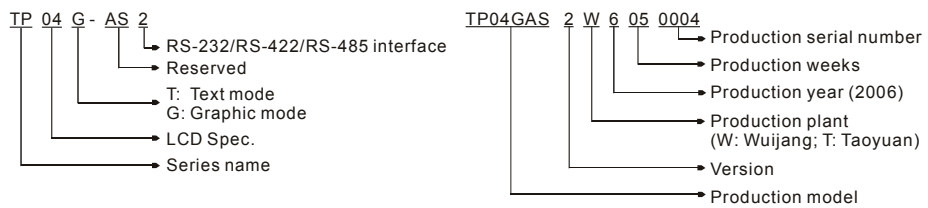

### 1.2 Product Outline

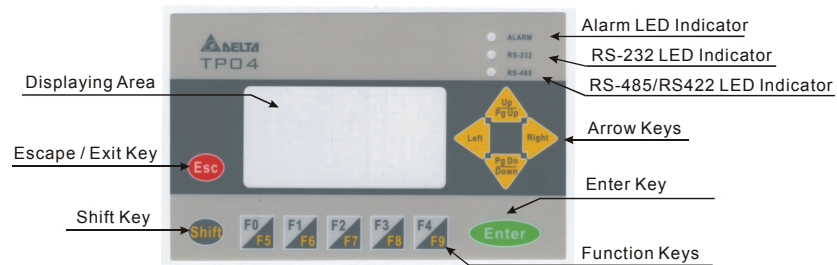

### 1.3 Panel Function Explanation

PANEL COMPONENT	EXPLANATION
Alarm LED Indicator (RED)	Status 1: When power is on, LED will start to blink slowly Status 2: When there is an abnormal situation, LED will blink quickly along with an alarm sound.
RS-232 LED Indicator (Yellow)	LED will blink when transmits program and communicates via RS-232.
RS-485 / RS-422 LED Indicator (Green)	LED will blink when communicates via RS-485 / RS-422.
Displaying Area	Liquid Crystal Module display area. It is used to display current program status.
Escape / Exit Key	It is used to cancel an incorrect input, or to exit a programming step.

PANEL COMPONENT	EXPLANATION
Shift Key	It is used to select function keys F0 ~ F9 and other keys for special function.
Arrow Keys	UP / Pg Up: It is used to increase the value or move up one page. Pg Dn / DOWN: It is used to decrease the value or move down one page. Left: This key is left direction key and it can be used to select the position of the value. Right: This key is right direction key and it can be used to select the position of the value.
Enter Key	It is used to input a value or accept a programming command.
Function Keys	F0 / F5: It is used to be constant 0 (F0) and 5 (Shift+F0) when it is in the system menu, the user can use it to define functions separately when they are in user page. F1 / F6: It is used to be constant 1 (F1) and 6 (Shift+F1) when it is in the system menu, the user can use it to define functions separately when they are in user page. F2 / F7: It is used to be constant 2 (F2) and 7 (Shift+F2) when it is in the system menu, the user can use it to define functions separately when they are in user page. F3 / F8: It is used to be constant 3 (F3) and 8 (Shift+F3) when it is in the system menu, the user can use it to define functions separately when they are in user page. F4 / F9: It is used to be constant 4 (F4) and 9 (Shift+F4) when it is in the system menu, the user can use it to define functions separately when they are in user page.

### 1.4 Back Panel

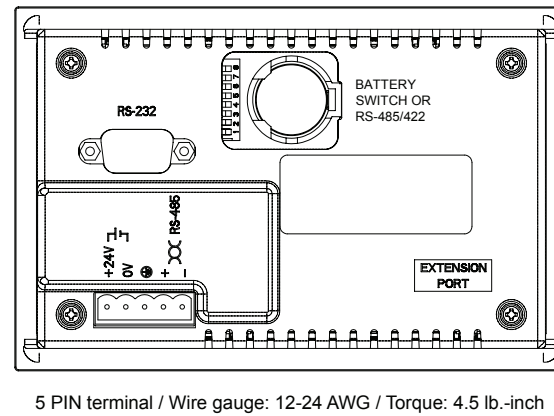

### 1.5 Dimension

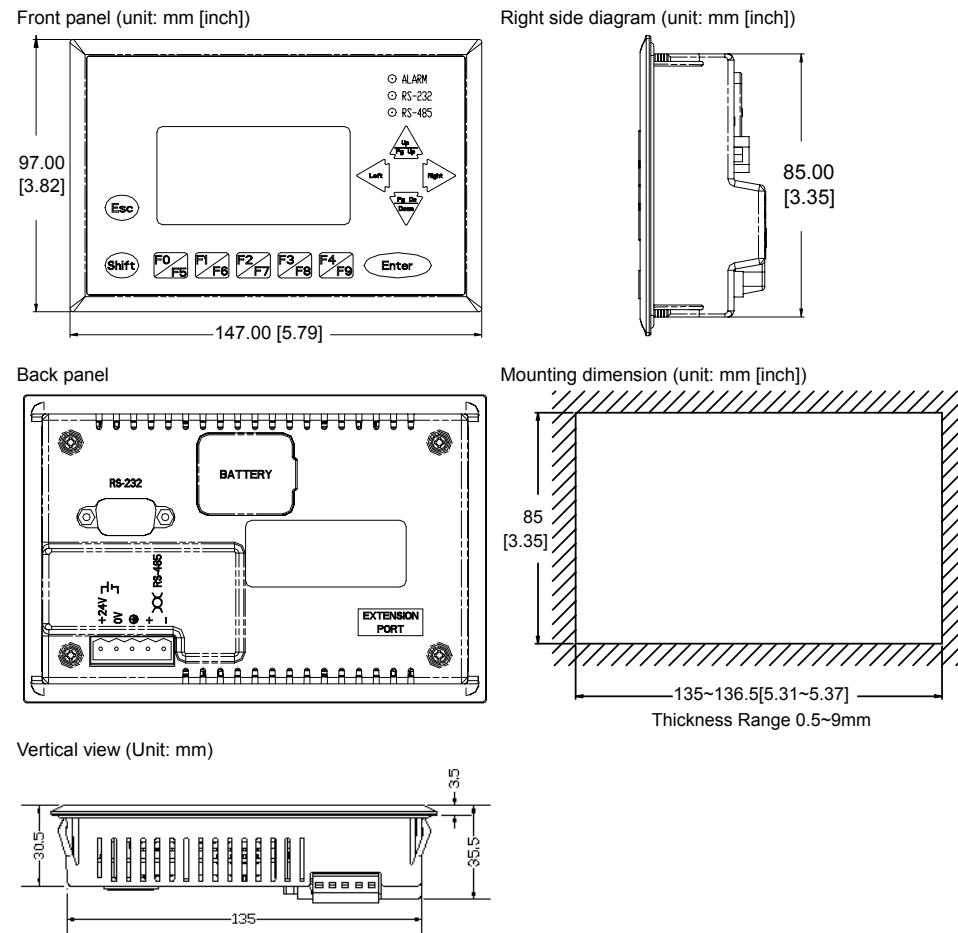

### 1.6 Installation

Please insert TP04 series to the opening hole of panel and tighten the screws. However, if a firm mounting TP04 series to the panel is needed, please use the mounting fixed support accessory which is packed together with TP04 series, then insert the fixed support in the back and tighten the screws.

⚠ If the fixed support is not installed well, Delta will not guarantee the waterproof function. The screw torque should be 4-5(kg-cm). DO NOT exceed this specification when tightening the screws; otherwise TP04 series may be damaged. Please leave sufficient space (more than 50mm) around the unit for heat dissipation.



- Do not install and mount TP04 series in the following environment.**
- A location subjected to Airborne dust, metallic particles, oil and smoke, corrosive or flammable gases and liquids.
  - A location where temperature and humidity will exceed specifications.
  - A location where vibration and shock will exceed specifications.

❖ The flat surface should be a UL Type 4 "Indoor Use Only" enclosure or equivalent (IP65 / NEMA4). Please refer to the figures below.

Please leave sufficient space (more than 50mm) around the unit for heat dissipation.  
Thickness: 0.5-9.0mm

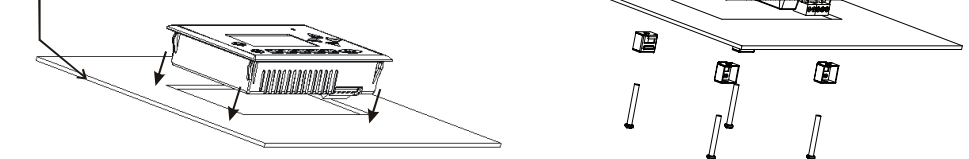

## 2 Function Specifications

ITEM	TP04G-AS2
Screen Type	STN-LCD
Display Color	Monochromatic
Backlight	The back-light automatic turn off time is 1 ~ 99 minutes (0 = do not turn off) (The back-light life is about 50 thousand hours at 25°C)
Resolution	128x64 dots
Display Range	(W) x (H) = 72 x 40 (unit: mm); 3.00" (diagonal preferred)
Contrast Adjustment	10 levels of adjustment
Language / Font	ASCII: (Code page 850) Alphanumeric (including European characters) Taiwan: (Big 5 codes) Traditional Chinese Fonts China: (GB2324-80 codes) Simplified Chinese Fonts
Display Text	5x8 dots: 25 characters x 8 rows
	8x8 dots: 16 characters x 8 rows
	8x12 dots: 16 characters x 5 rows
	8x16 dots: 16 characters x 4 rows
Font Size	ASCII: 5x8, 8x8, 8x12, 8x16
Alarm LED Indicator (RED)	1. Power on indication (Blink for three times) 2. Communication error alarm 3. Special indication by user programming
RS-232 LED Indicator (Yellow)	It will blink when transmitting program and communicating by using RS-232.
RS-485 / RS-422 LED Indicator (Green)	It will blink when communicating by using RS-485 / RS-422.
Program Memory	256KB flash memory
Serial Communication Port RS-232 (COM1)	Unsynchronized transmission method: RS-232 Data length: 7 or 8 bits, Stop bits: 1 or 2 bits Parity: None/Odd/Even, Transmission speed: 9,600bps ~ 115,200bps RS-232: 9 PIN D-SUB male
Extension Communication Port RS-422 (COM1) RS-485 (COM2)	Unsynchronized transmission method: RS-485 / RS-422 Data length: 7 or 8 bits, Stop bits: 1 or 2 bits Parity: None/Odd/Even, Transmission speed: 9,600bps ~ 115,200bps RS-422: 9 PIN D-SUB male RS-485: 5 PIN removal terminal
Extension Interface	1. Update firmware version 2. The slot for program copy card
Battery Cover	DC 3V battery for HMI
5 PIN Removal Terminal	Include DC 24V input and RS-485 communication input

## 3 Electrical Specifications

Specifications	TP04G-AS2
Display	Monochromatic STN LCD
Effective Display Area	(W) x (H) = 72 x 40 (unit: mm); 3 inches
Display Resolution	5x8 dots: 25 characters x 8 rows
	8x8 dots: 16 characters x 8 rows
	8x12 dots: 16 characters x 5 rows
	8x16 dots: 16 characters x 4 rows
LCD Contrast Adjustment	Set by Software, adjust the contrast by the press button in the function table
LCD Backlight Type	LED Backlight: Automatic Turn-off Setting
Function / Numeric Keys	F0 ~ F9, ESC, SHIFT, ENTER and Arrow Keys
External Input Power	24V (3.5W Max.)

Specifications	TP04G-AS2
Memory Capacity	256K Byte
CPU	Hitachi HD64F3064F
RAM of System	32K Byte
Communication Interface	COM1: RS-232 / RS422 COM2: RS-485
Waterproof Class of Front Panel	IP65 / NEMA4
Operating Temperature for Hardware	0 ~ 50°C; 20 ~ 90% RH (non-condensing)
Storage Temperature for Hardware	-20 ~ 60°C
Vibration	5Hz ≤ f < 9Hz = Continuous: 1.75mm / Occasional: 3.5mm 9Hz ≤ f ≤ 150Hz = Continuous: 0.5g / Occasional: 1.0g
Shock	15g peak, 11ms duration, half-sine, three shocks in each direction per axis, on 3 mutually perpendicular axes (total of 18 shocks)
Radiated Emission	CISPR11, Class A
Electrostatic Discharge Immunity	EN61000-4-2
Radiated Immunity	EN61000-4-3
Electrical Fast Transient	EN61000-4-4
Weight / Dimensions	0.24kg; 147×97×35.5mm (Width(W) × Height(H) × Deep(D))
Cooling Method	Natural Air Cooling

## 4 Program Copy Card

TP04 series provides Program Copy Card Function to copy user program, system function and passwords that is different from the copy program. It is used to copy the whole HMI environment settings and application programs to another HMI rapidly. Using Program Copy Card saves time and manpower. The operation is as follows.

❖ **Definition: Program Copy Card → PCC, TP Series → TP**

	(TP→PCC)	(PCC→TP)
Step 1	Turn the switch on the PCC to TP→PCC	Turn the switch on the PCC to PCC→TP
Step 2	Insert the PCC into the extension slot of TP	Insert the PCC into the extension slot of TP
Step 3	Input the power to TP	Input the power to TP
Step 4	It will display "remove PCC" on the screen and power on again.	It will display "remove PCC" on the screen and power on again.

❖ **HMI Display Message**

	(TP→PCC)	(PCC→TP)
Step 1	If the TP model type does not correspond with the model type of program of PCC, TP will display "TP series and PCC is different. Press Enter to Confirm TP series→PCC. Press Esc to Exit".	If there is no program in PCC, TP will display "The PCC is Empty. PCC→TP series is illegal".
Step 2	TP will display "TP→PCC series Please wait!" during transmission.	TP will display "PCC→TP series Please wait!" during transmission.
Step 3	TP will display "Please Remove the PCC and Reboot" when transmission is completed.	TP will display "Please Remove the PCC and Reboot" when transmission is completed.

## 5 Password Function

If the user forgot the password, the password can be cleared by using the following code: **8888**. This universal code will clear the password and all TP04 series internal programs. The TP04 series will be reset to the factory settings by using this code also. Please pay close attention when using it.

❖ **The password can be the alphabet from A to Z or the number from 0 to 9. But it must use the function keys F0 ~ F9 to input the password characters. Please refer to the following table.**

Function Key	Use Method	Function Key	Use Method
F0 / F5	Scrolls in a loop as follows 0→5→A→B→C→D→E→F→0	F3 / F8	Scrolls in a loop as follows 3→8→Q→R→S→T→U→V→3
F1 / F6	Scrolls in a loop as follows 1→6→G→H→I→J→K→1	F4 / F9	Scrolls in a loop as follows 4→9→W→X→Y→Z→4
F2 / F7	Scrolls in a loop as follows 2→7→L→M→N→O→P→2		

## 6 Hardware Operation

When the user wants to startup TP04 series, a 24VDC power is needed. After applying 24VDC power to TP04 series, it will enter into the startup display and then enter the user-designed program. Pressing Esc key and holding on for 5 seconds can return to system menu. There are five selections in the system menu and are described below.

SELECTIONS	EXPLANAION
Download Program	Use the connection cable (DVPACAB530) to connect the TP04 serial communication port RS-232 to a PC. Then use the TPEdit software to download an application program to TP04.
Upload Program	Use the connection cable (DVPACAB530) to connect the TP04 serial communication port RS-232 to a PC. Then use the TPEdit software to upload an

SELECTIONS	EXPLANAION
	application program from TP04.
Copy Program	Transfer a program between two TP04 units. 1: transmit programs 2: receive programs When transmit programs and data between two TP04 units. Set one TP04 to "Receive Program" mode and the other TP04 to "Transmit Program" mode. Please use twisted pair wires to connect the two units via the RS-485 ports.
TP04 Settings	There are 9 items that used to modify TP04 system settings: 1. Communication protocol: Setting the address of TP04, the control port of PLC, and the communication string for either RS-232 or RS-485. 2. Contrast: Adjust the contrast of LCM display screen. 3. Back-light: adjust the automatic turn off time of LCM. Setting range is 00 ~ 99 minutes. If set to 00, the LCM Back-light will not turn off. 4. Date and Time: It is used to set the TP04 built-in RTC including year, month, day, hour, minute, second and week. Also the internal battery capacity display is shown here. 5. Buzzer: Used to set the buzzer sound, normal mode or quiet mode. 6. Language Setting: Used to set the displayed language. English, Traditional Chinese, Simplified Chinese or user defined language. 7. Password setting: Used to set, enable, and disable the password function. If the password function is enabled, it will require the user to input a password before entering any system menu. The factory password is <b>1234</b> . 8. Startup display: Used to select the TP04 startup display. User can select "user defined" to use the file that designed by TPEdit and download to TP04. 9. Comm. indicator: The user can determine if the RS-232 and RS-485 LEDs will blink or not during communication.
PLC Connection	There are three methods to connect to PLC: 1. Using TP04 serial communication port (COM1) RS-232: set 8-pin DIP switch to RS-485 mode and connect the cable (DVPACAB215 or DVPACAB230) to program communication I/O RS-232C of PLC. 2. Using extension communication port (COM2): set 8-pin DIP switch to RS-485 mode and connect 5-pin removal terminal of extension communication port to RS-485 of PLC with twisted pair. 3. Using extension communication port (COM2): set 8-pin DIP switch to RS-422 mode and connect four pins (6, 7, 8, 9) of 9 PIN D-SUB male to RS-422 of PLC with 4-wire cable.
Execution	Execute the internal program that download from TPEdit or transmitted from other TP04 units. When program is in execution, the user can return to system menu by pressing Escape / Exit (Esc) key for 5 seconds.

## 7 Communication Connection

❖ **TP04G may connect to a PC by using connection cable DVPACAB515**

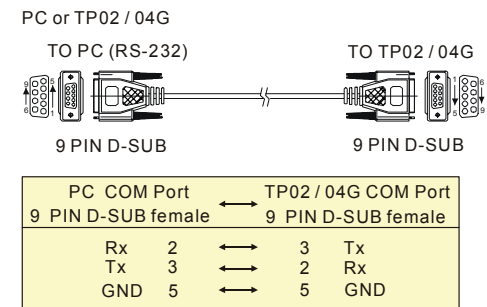

❖ **TP04G may connect to a DVP-PLC by using connection cable DVPACAB215 / DVPACAB230 / DVPACAB2A30**

1. DVPACAB215 / DVPACAB230

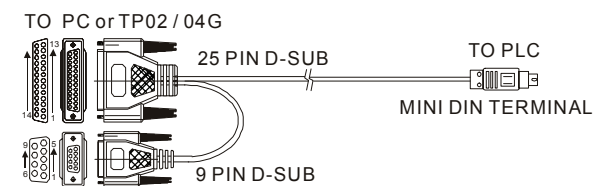

2. DVPACAB2A30

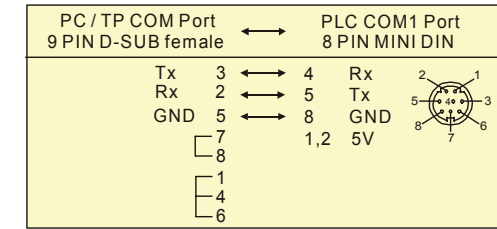
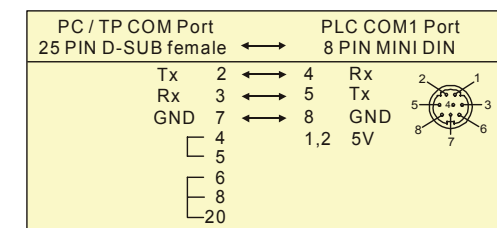
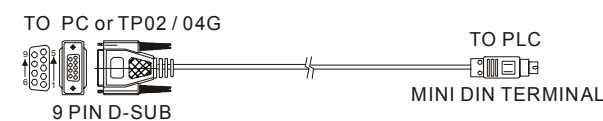

❖ **The Pin definition of 9 PIN D-SUB**

1. RS-232

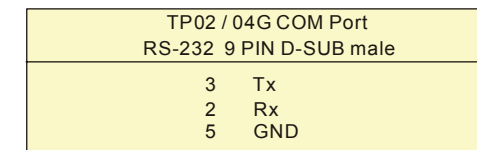

2. RS-422

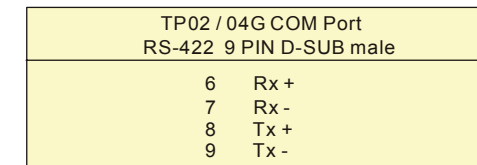

3. DVPACAB630 (RS-422)

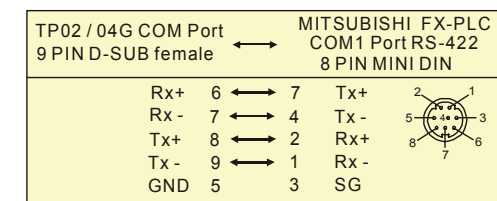
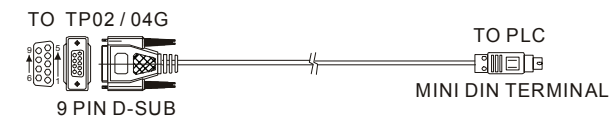

❖ **Switch between RS-422 / RS-485 (by using 8-PIN DIP switch)**

8-PIN DIP Switch	RS-485	RS-422
SW1 ~ SW4	On	Off
SW5 ~ SW8	Off	On

## 8 Battery Life and Precision of Calendar Timer

❖ **Battery Life**

Temperature (°C)	-20	0	20	60
Life (Year)	1.972	2.466	2.712	2.835

❖ **Precision of Calendar Timer**

- At 0°C / 32°F, less than -117 seconds error per month.
- At 25°C / 77°F, less than 52 seconds error per month.
- At 55°C / 131°F, less than -132 seconds error per month.